

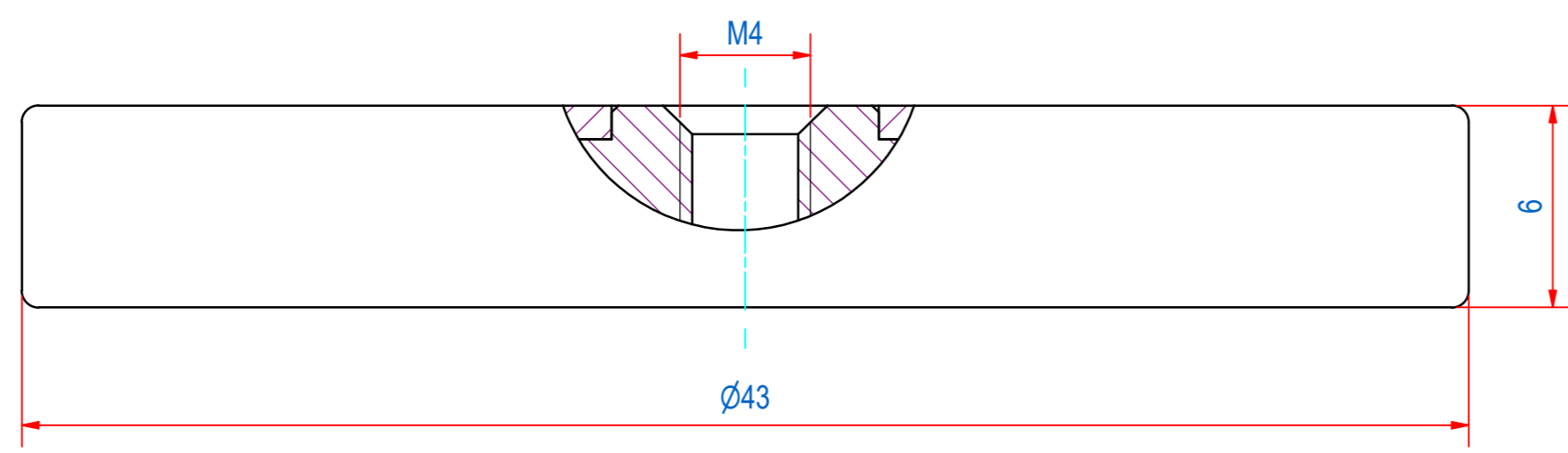

DOC.NR.	REV	DATE	BY	DESCRIPTION
GM17500	-	11-8-2020	TM	ORIGINAL DRAWING

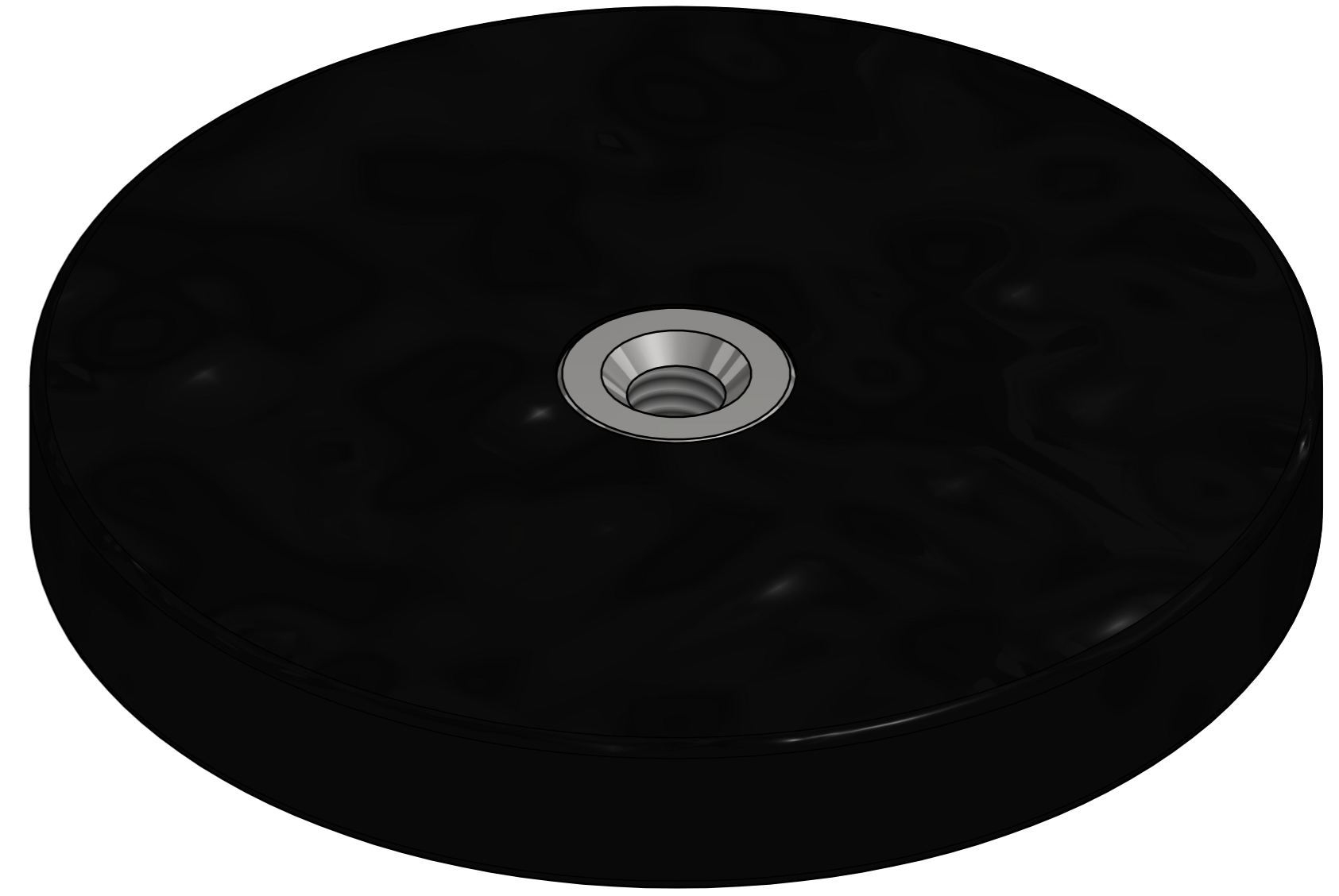
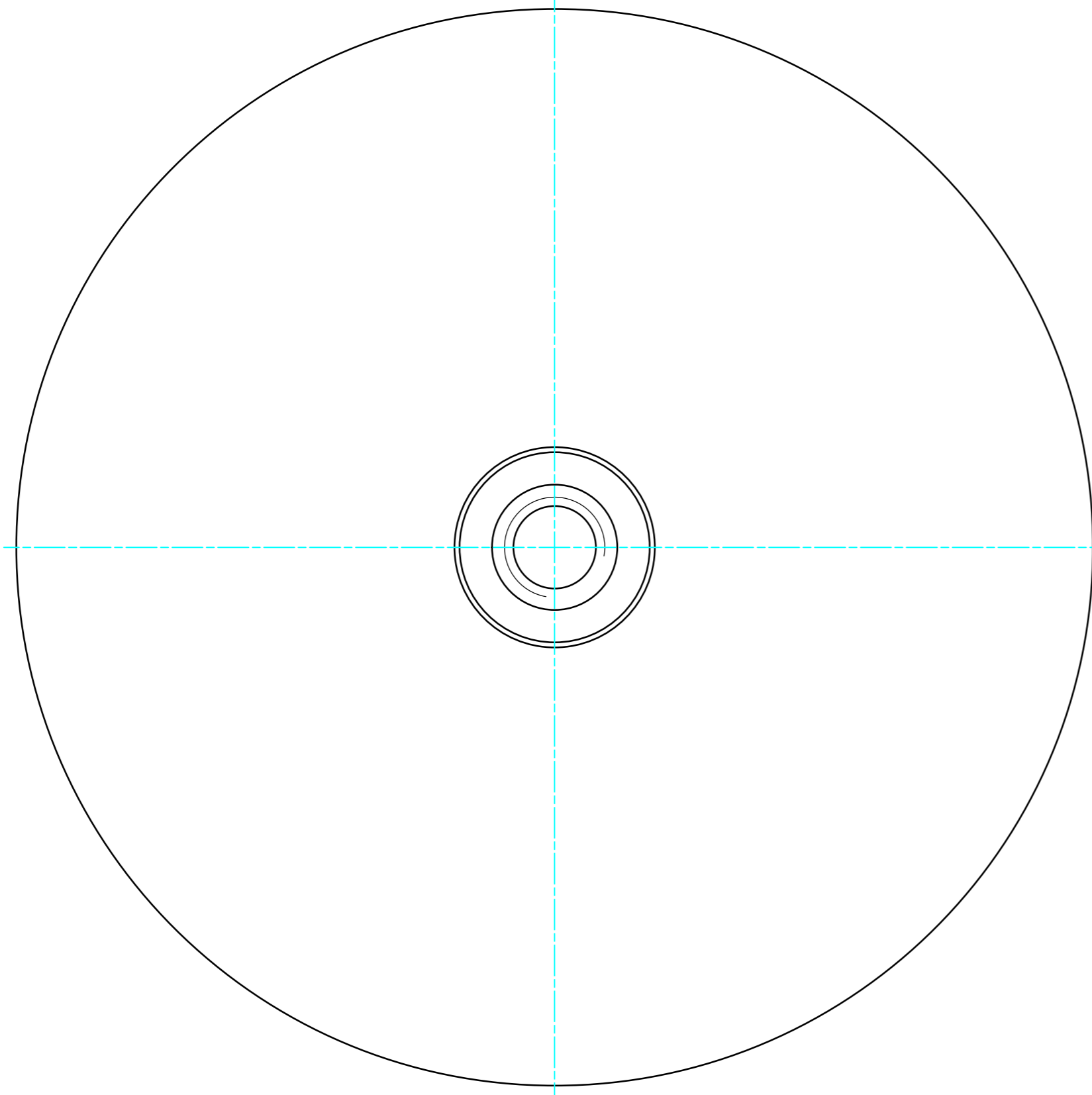

RAW MAT.	Quantity	Material Number	Material Description	Length (mm)	Width (mm)
1					
Sheet: A2		Extra info: POT MAGNET NdFeB RUBBER COATED		General tolerance: ISO 2768- mK	
Drawn: TM		Weight (kg): 0,014		Drawn according: ISO268; ISO1101; ISO2553	
Date: 11-8-2020				Status: Standard	
Spare part: False				Customer reference number:	
Quick search: POTGM		© All rights reserved. Reproduction is not permitted without written permission of GOUDSMIT Magnetic Systems BV		Document number: GM17500 Doc.Rev: -	
Description: PM-RTI-N-RB-D43x6xM4				Part number: GM17500 Rev: -	