

REV	DATE	BY	DESCRIPTION
A	8.2.2013	JDL	ORIGINAL DRAWING
B	9.11.2016	PH	NEW STANDARD LENGTH (1050mm)

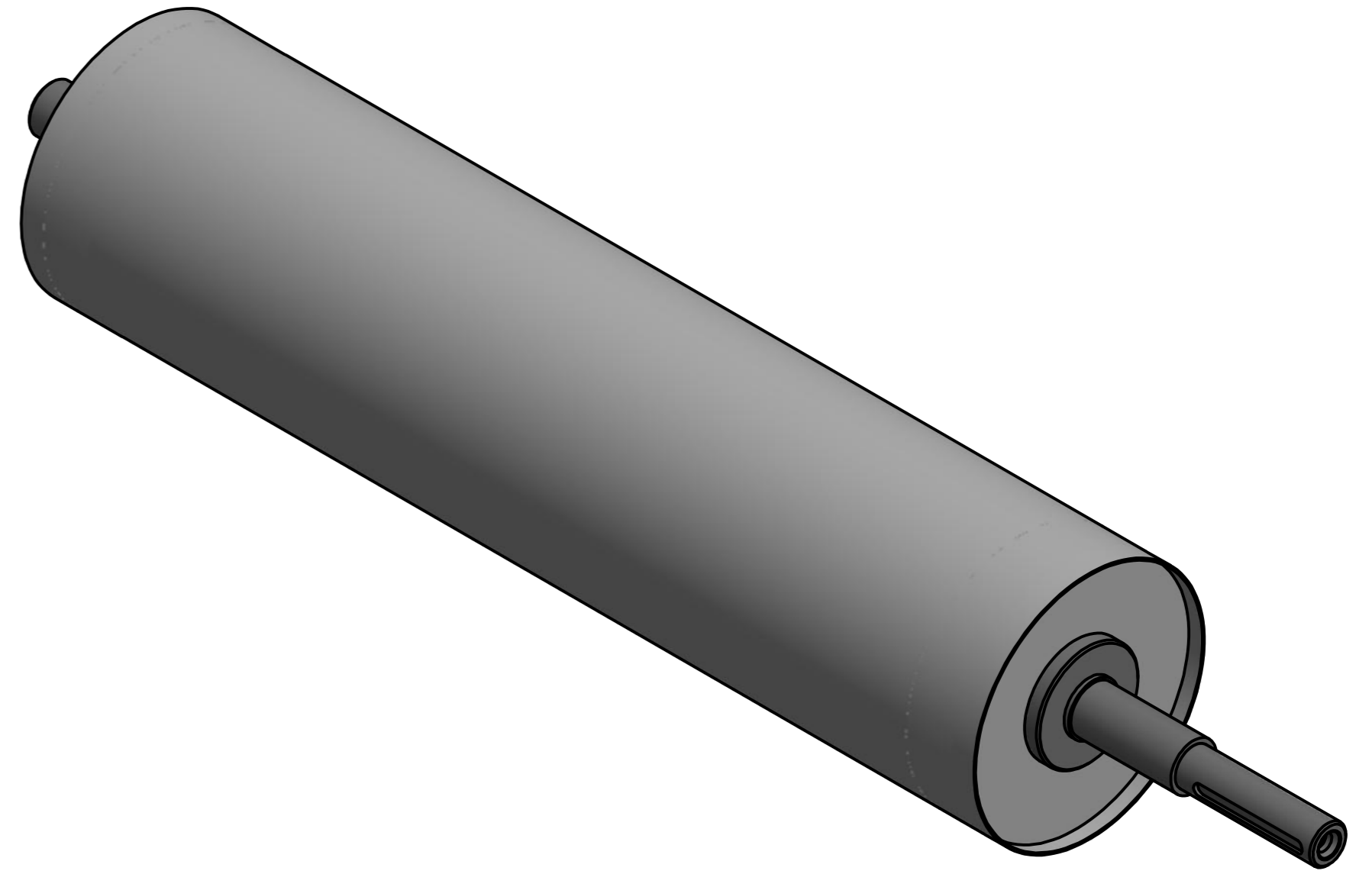
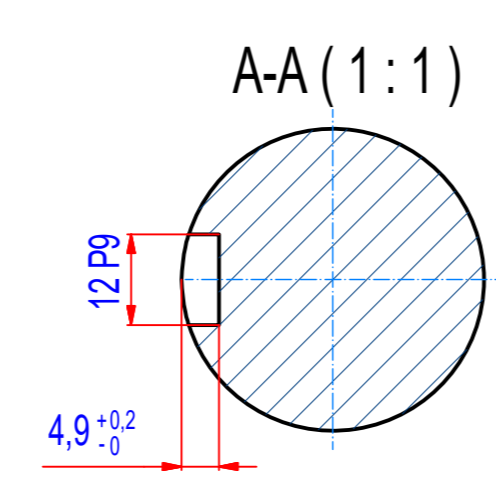
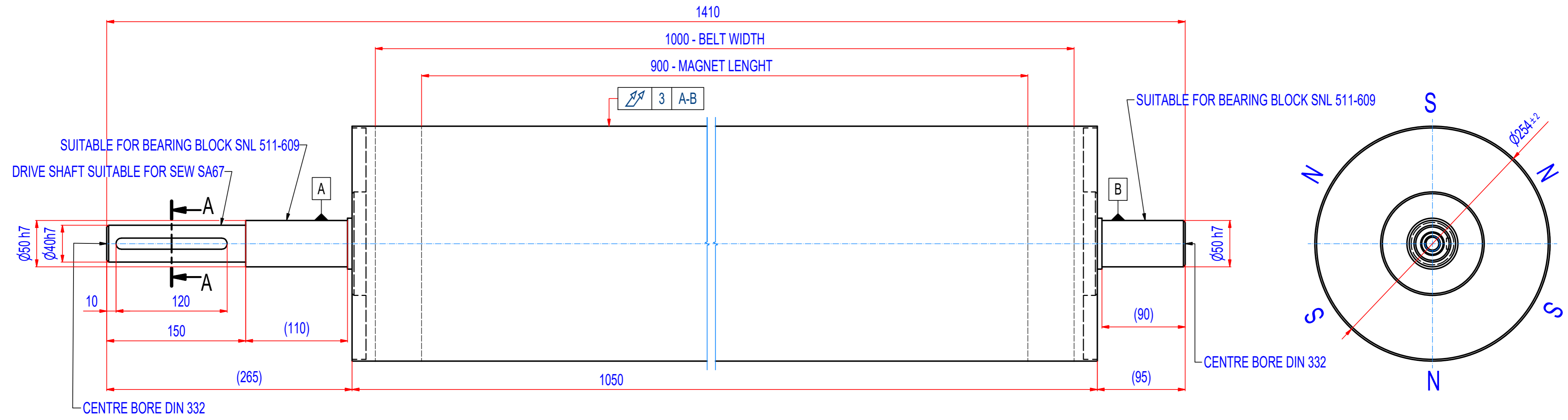

**SPECIFICATIONS**

- SUITABLE FOR BELT WIDTH: 1000 mm
- MAGNET TYPE: Ferrite
- NUMBER OF POLES: 6
- SURFACE MAG. INTENSITY: 1800 Gauss
- SHAFT TYPE: REMOVABLE,EQUIPPED WITH CLAMP BUSHINGS
- OVERALL WEIGHT: 221 kg
- CROWNING: NO
- RUBBER LAYER: NO

IF NOT SPECIFIED ON DRAWING, LINEAR DIMENSION TOLERANCES PER ISO 2768-1 CLASS C, GEOMETRICAL TOLERANCES PER ISO 2768-1 CLASS L

Sheet: A2	Extra info:	General tolerance: ISO 2768 - cL
Drawn: PH	Weight (kg): 221	Drawn according: ISO268; ISO1101; ISO2553
Date: 25.02.2019		Status:
Predecessor:		Customer reference number:
Quick search: XRHR D254	<p>© All rights reserved. Reproduction is not permitted without written permission of GOUDSMIT Magnetic Systems BV</p>	Product key: RHP-F254A06-100-RSD-BA
Description: Magnetic headroller, Ferrite, D254 - W1050		Part number: RHAF25100000