

REV	DATE	BY	DESCRIPTION
-	04.05.2022	PH	Source ROFC080340, covering according size 3 for mobile unit

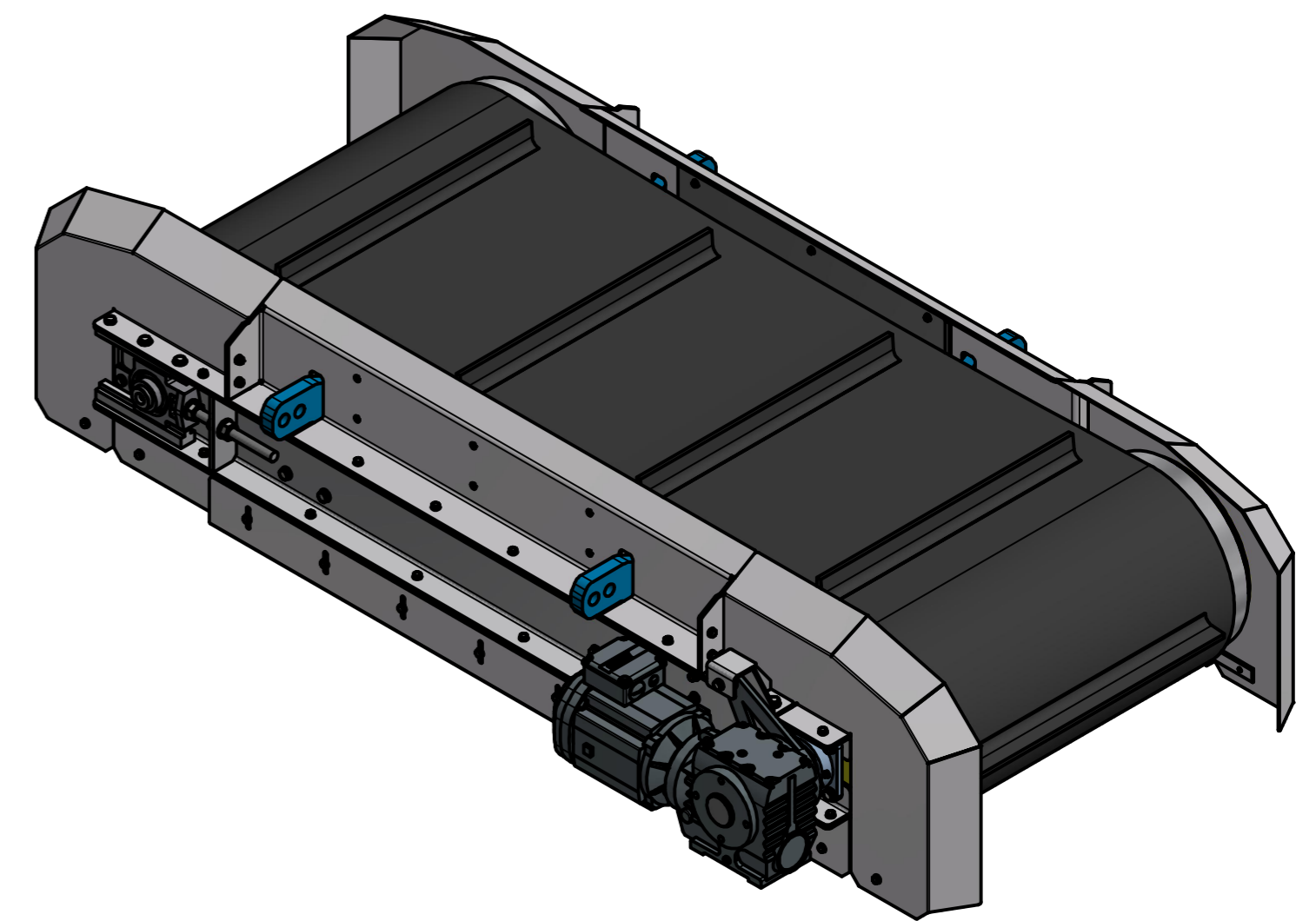
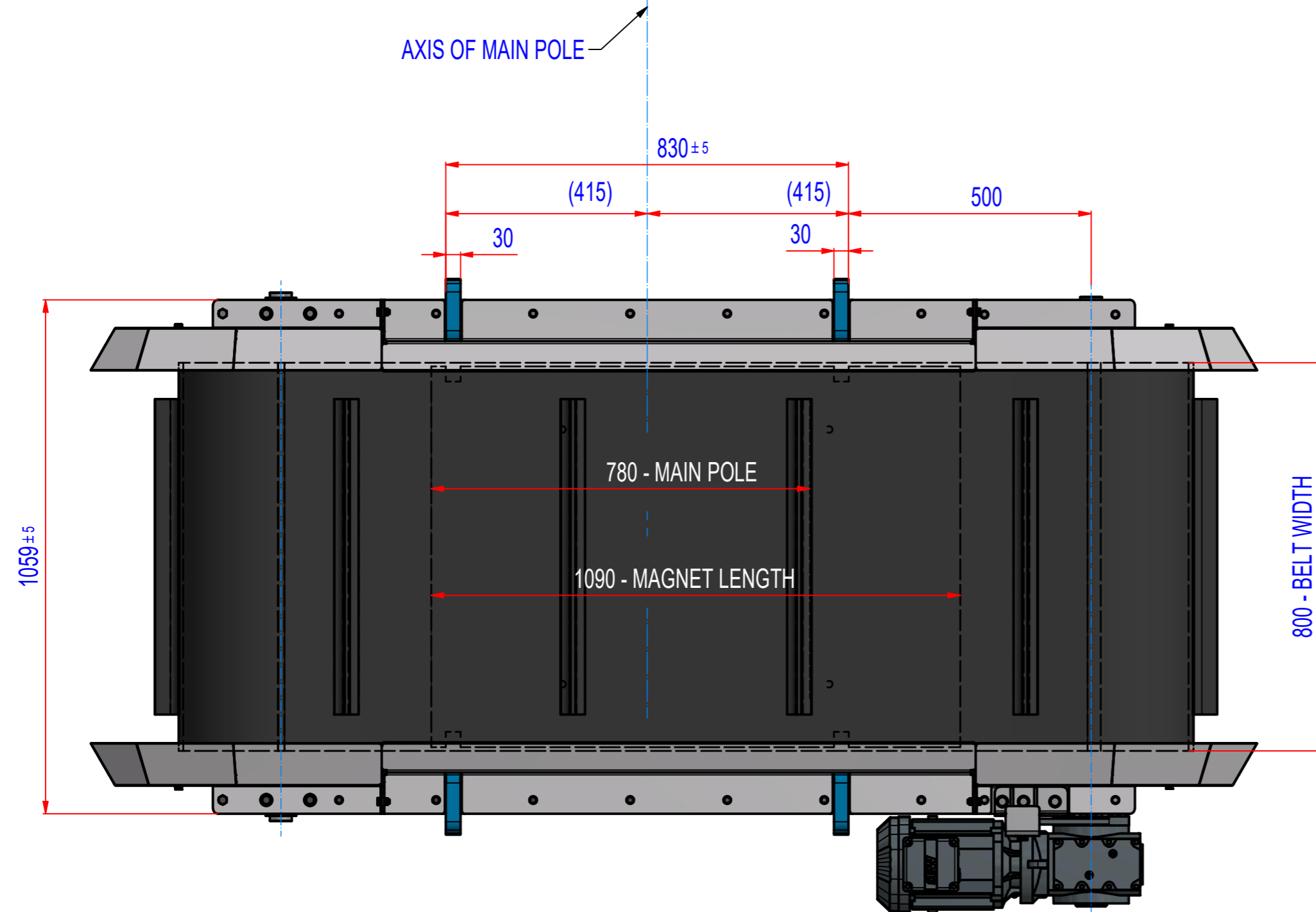
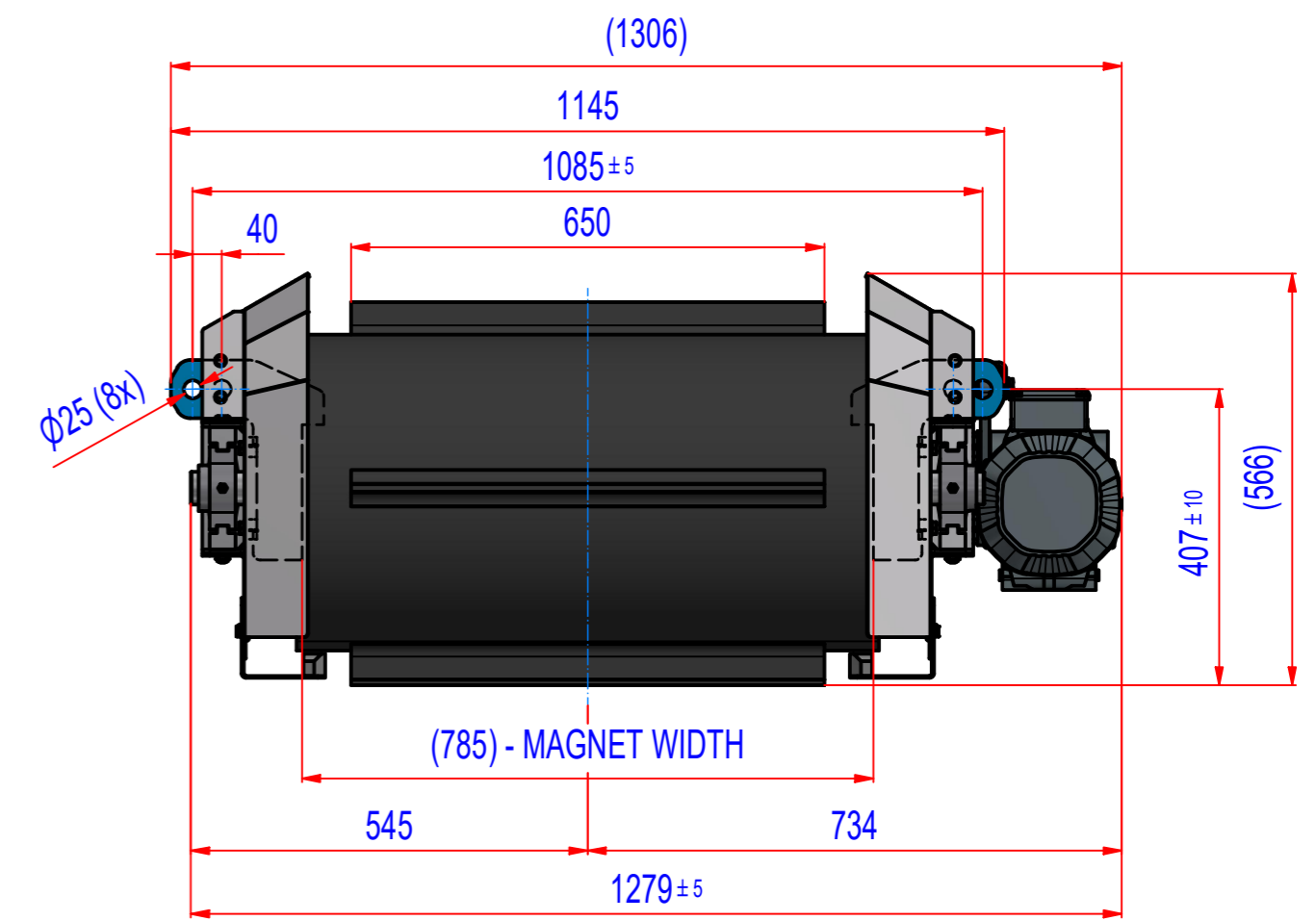
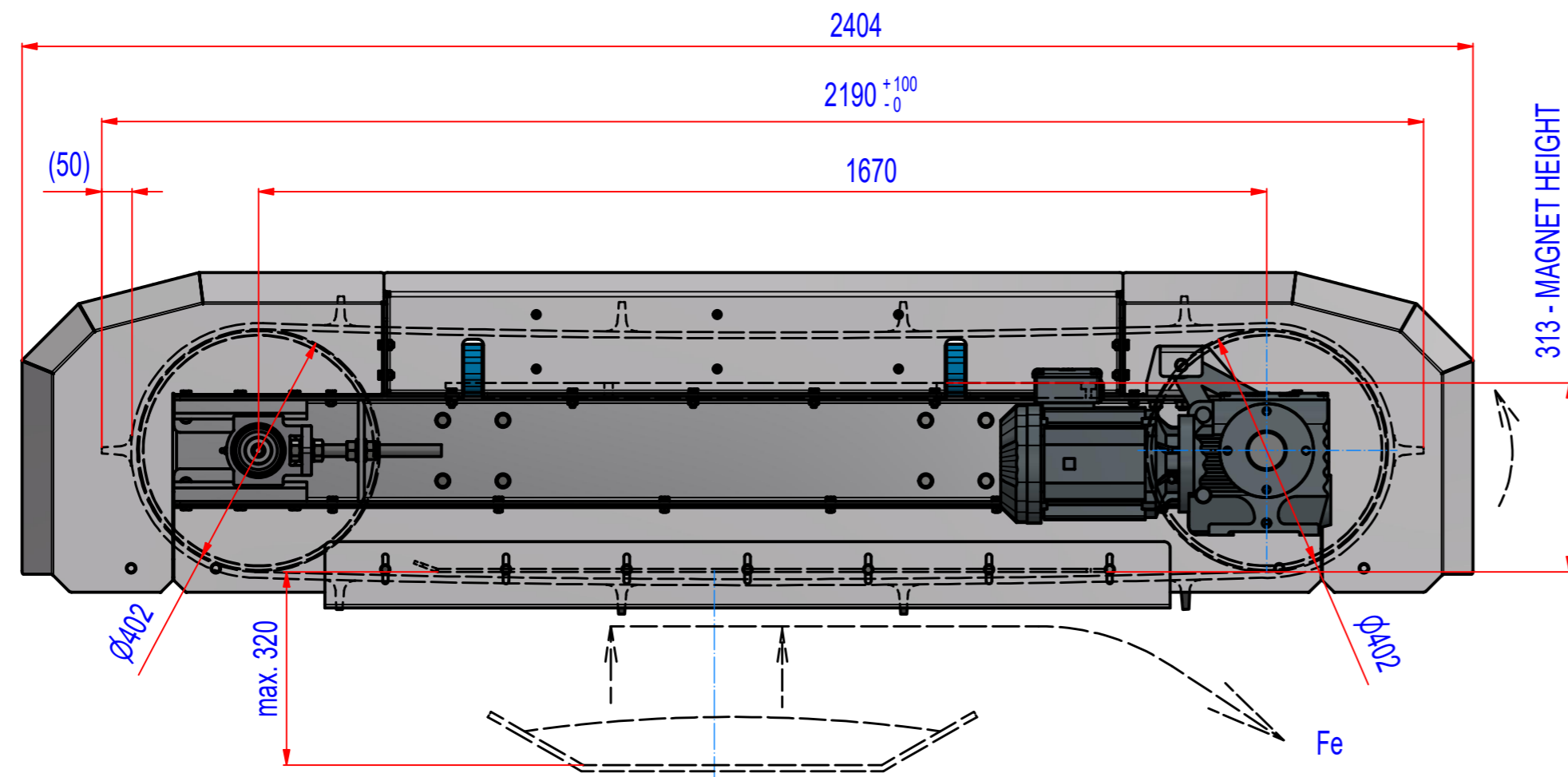

POZ./POS.	Č. SOUČÁSTI/ PART NUMBER	POPIS / DESCRIPTION	HMOT./ WEIGHT
1	B581_000000	ROFC080341	1587,4
Sheet: A2 Drawn: PH Date: 04.05.2022 Predecessor: ROFC080340 Quick search:		Extra info: GOUDSMIT MAGNETICS <small>© All rights reserved. Reproduction is not permitted without written permission of GOUDSMIT Magnetic Systems BV</small>	General tolerance: ISO 2768 - cL Drawn according: ISO268; ISO1101; ISO2553 Status: Customer reference number: Product key: ROP-F4-C-080-W-G-R-B-B-M-NA Part number: ROFC080341 Rev: -
Description: Overbelt separator, Ferrite, size 4, W800, spec for mobile			