

REV	DATE	BY	DESCRIPTION
-	29.04.2022	EN	New Vault, production tolerances added

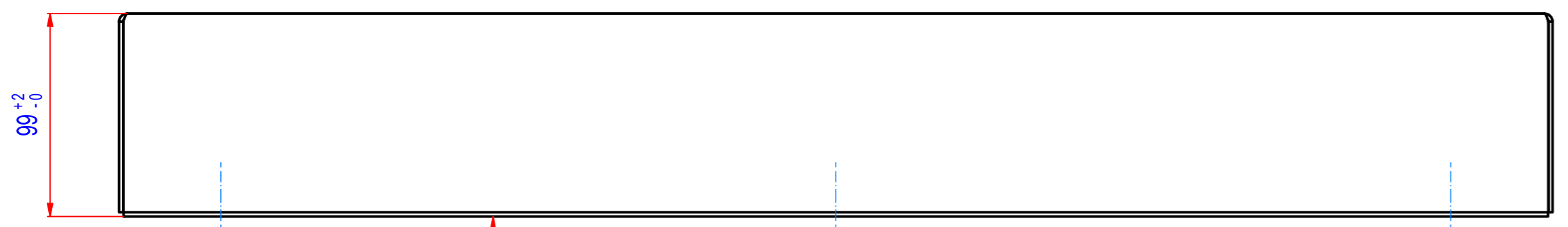

2

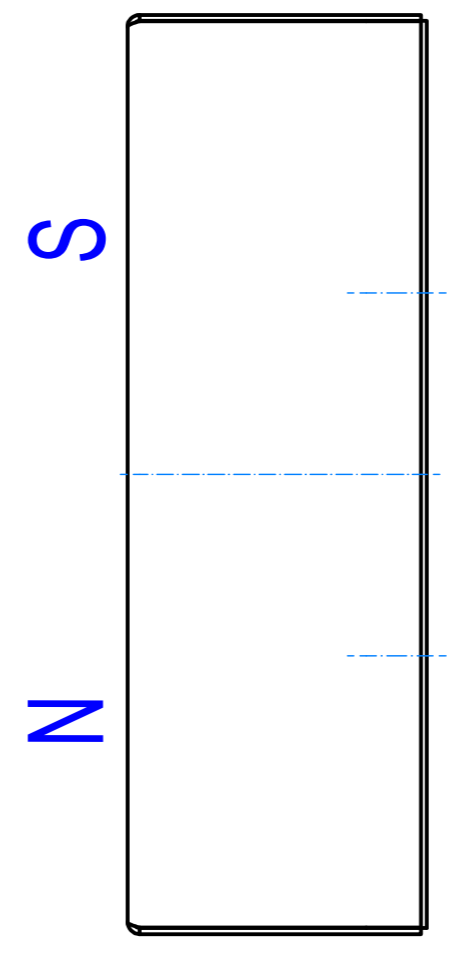
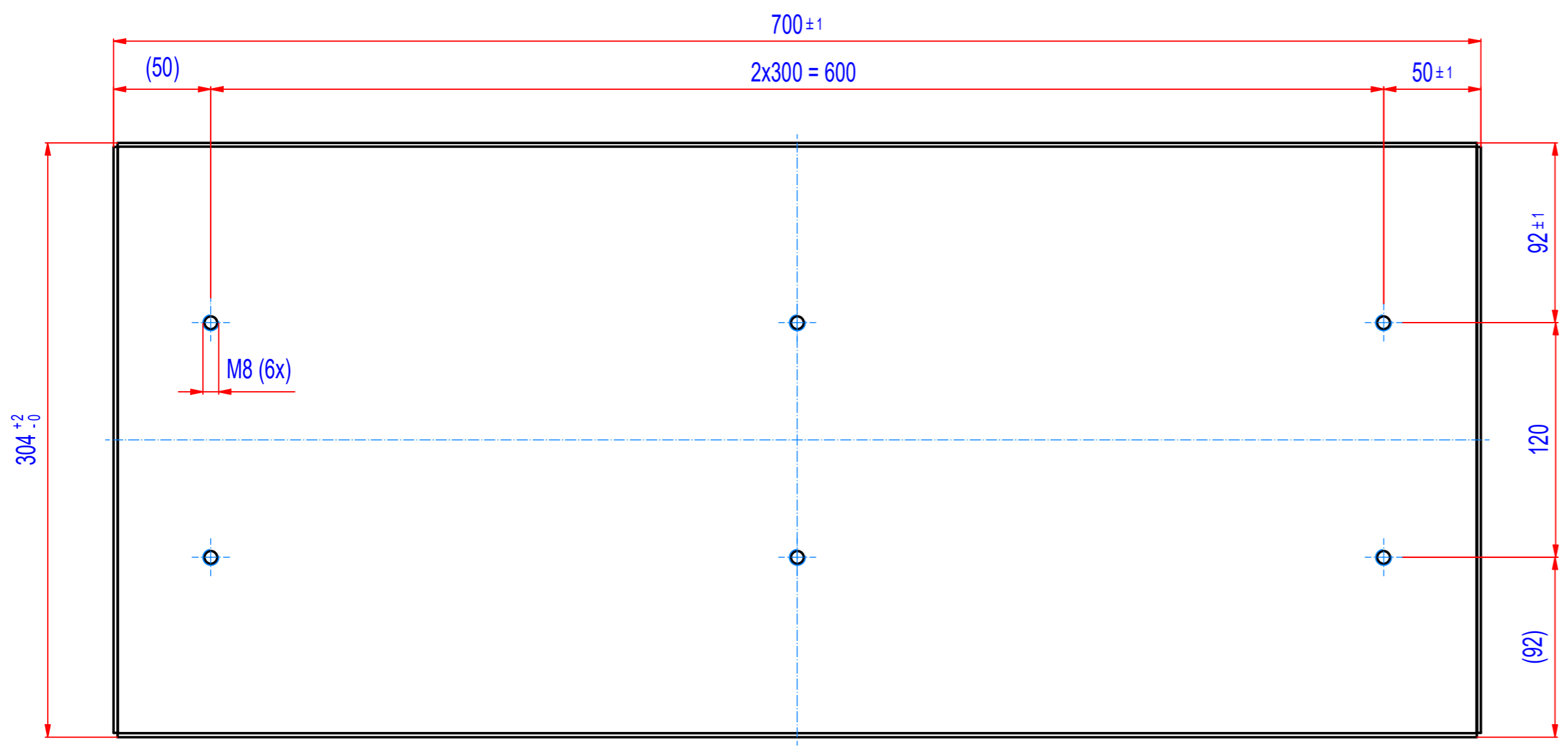
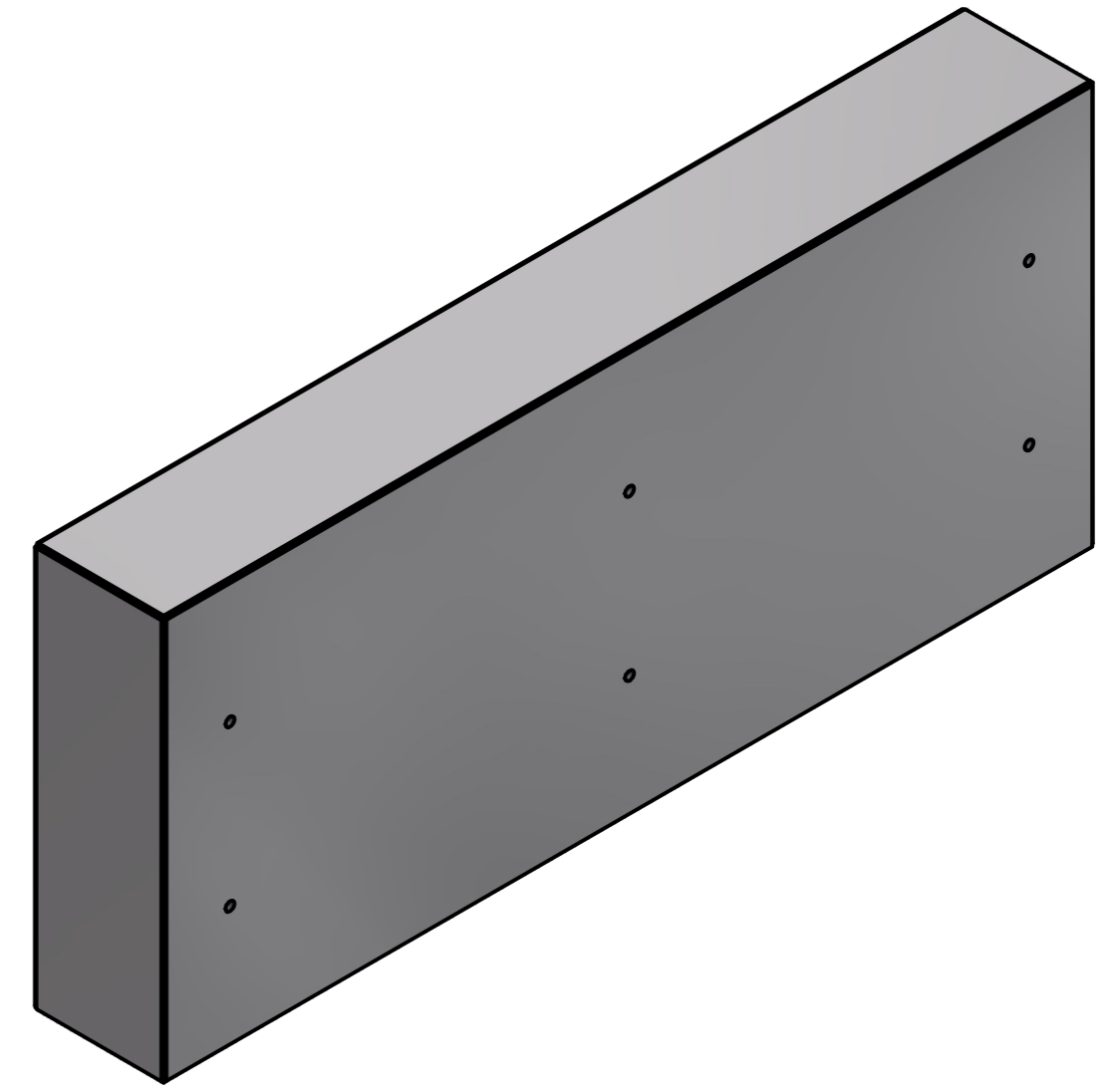

	Sheet: A2	Extra info:	General tolerance: ISO 2768 - cL
Drawn: EN	Weight (kg): 104.2		Drawn according: ISO268; ISO1101; ISO2553
Date: 29.04.2022	Predecessor:		Status:
Quick search: XSVM 304x99	© All rights reserved. Reproduction is not permitted without written permission of GOUDSMIT Magnetic Systems BV		Customer reference number:
Description: Plate magnet, ferrite, 304x99, L=700			Product key: SVM-F-304x99-0700-B-F0E
		Part number: SVMF050700	Rev: -